

# Persianas



**P**ROPERFIL

**Catálogo General  
Cortinas de Enrollar**

# Índice

3.....	Motores
5.....	Acc. Motores
9.....	Lamas
12.....	Cajones
14.....	Testerros
17.....	Guías
20.....	Ejes
22.....	Recogedores
26.....	Discos
28.....	Cápsulas
31.....	Pasacintas
33.....	Accesorios
38.....	Carta de Colores*

\* Información sobre carta de colores

# Motores

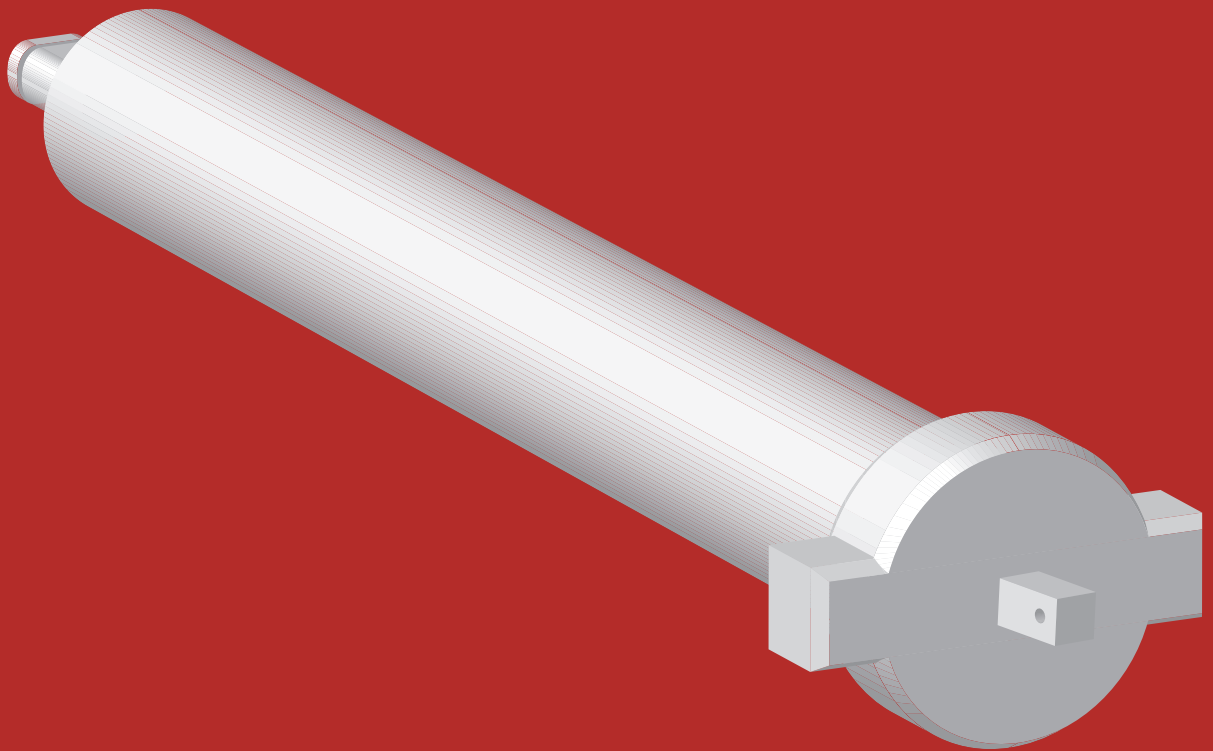

Descripción	Código	Medidas	Foto
<p>Motor MILANO 19K Estándar P/ 40mm</p> <p>Motor MILANO 19K Electrónico P/ 40mm</p> <p><b>Adaptadores incluidos.</b></p>	<p>DO19</p> <p>DO19E</p>	<p>D = 35 Nm = 10</p> <p>W = 139 RPM = 17</p> <p>D = 35 Nm = 10</p> <p>W = 139 RPM = 17</p> <p>P/ Eje 40 mm</p>	
<p>Motor MILANO 80K Estándar P/ 60 o 70 mm 230 W.</p> <p>Motor MILANO 80K Elect. P/ 60 o 70 mm 230 W.</p> <p><b>Adaptadores incluidos.</b></p>	<p>DO80</p> <p>DO80E</p>	<p>D = 45 Nm = 50</p> <p>W = 230 RPM = 12</p> <p>D = 45 Nm = 50</p> <p>W = 230 RPM = 12</p> <p>P/ Eje 60 o 70 mm</p>	
<p>Motor MILANO Estándar 120K P/ 70 mm</p> <p>Motor MILANO Estándar 140K P/ 70 mm</p> <p>Motor MILANO 220K Estándar P/ 70 mm C/ Asistencia Manual</p> <p><b>Adaptadores incluidos.</b></p>	<p>DO120</p> <p>DO140</p> <p>DO220</p>	<p>D = 59 Nm = 80</p> <p>W = 380 RPM = 15</p> <p>D = 59 Nm = 100</p> <p>W = 368 RPM = 12</p> <p>D = 59 Nm = 140</p> <p>W = 960 RPM = 7</p> <p>P/ Eje 70 mm</p>	
<p>Adaptadores (Rueda y Corona) (Incluidos c/ motor)</p> <p>Adaptadores (Rueda y Corona) (Incluidos c/ motor)</p> <p>Adaptadores (Rueda y Corona) (Incluidos c/ motor)</p>	<p>DOADPT</p> <p>DOADPT</p> <p>DOADPT</p>	<p>DO19</p> <p>DO19E</p> <p>DO80</p> <p>DO80E</p> <p>DO120</p> <p>DO140</p> <p>DO220</p>	



# Acc. Motores



Descripción	Código	Compatibles	Foto
Central Inteligente Smart Device	DOSD	DO19E / DO80E / DO01 DO05 / DO15 / DO01MINI DO74 / DO06 / DO07 / DORIN	
Emisor / Control de Radio - 1 Canal  Emisor / Control de Radio - 5 Canales  Emisor / Control de Radio - 15 Canales	DO01  DO05  DO15	DO74 / DO06 / DO07 / DORIN DO19E / DO80E  DO74 / DO06 / DO07 / DORIN DO19E / DO80E  DO74 / DO06 / DO07 / DORIN DO19E / DO80E	
Emisor / Control de Radio Mini - 1 Canal	DO01MINI	DO74 / DO06 / DO07 / DORIN DO19E / DO80E	
Receptor de Radio - Motores Max. 800 W	DO74	DO01 / DO05 / DO15 DO01MINI / DOSD Motores Estándar	
Llave / Interruptor con Receptor de Radio Incluido - Consumo Max 500 W	DO06	DO01 / DO05 / DO15 DO01MINI / DOSD DO227C (Caja Exterior) Motores Estándar	

DO227C

Descripción	Código	Compatibles	Foto
<p>Llave / Interruptor con Receptor de Radio</p> <p>Incluido - Consumo Max. 1000 W.</p> <p>Incluye X 2 DO01MINI</p>	DO07	<p>DO01MINI / DO01 / DO05</p> <p>DO15 / DODS</p> <p>Motores Metálica</p> <p>Motores Estándar</p>	
<p>Receptor de Radio Compacto (P/ C. Llana)</p> <p>Posibilidad de Añadir Cualquier Línea de Interruptor (Pulsador).</p> <p>Consumo Max. 300 W.</p>	DORIN	<p>DO01 / DO05 / DO15</p> <p>DO01MINI / DOSD</p> <p>DO19 / DO80</p>	
<p>Interruptor Exterior Estándar</p>	DO08	<p>Motores Estándar</p> <p>Motores Metálica</p>	
<p>Interruptor Exterior Cuadrado Estándar</p>	DO09	<p>Motores Estándar</p> <p>Motores Metálica</p>	 <p style="text-align: right;">DO227C</p>
<p>Interruptor Exterior Reforzado C / LLavín</p>	DO10	<p>Motores Estándar</p> <p>Motores Metálica</p>	

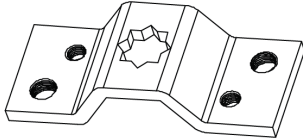
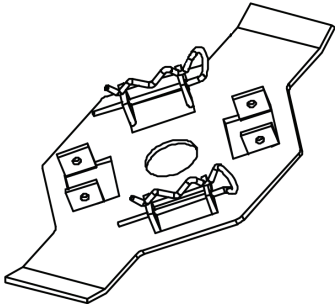
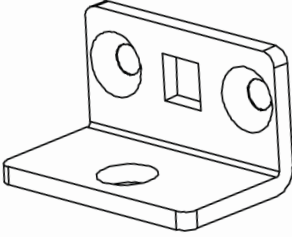
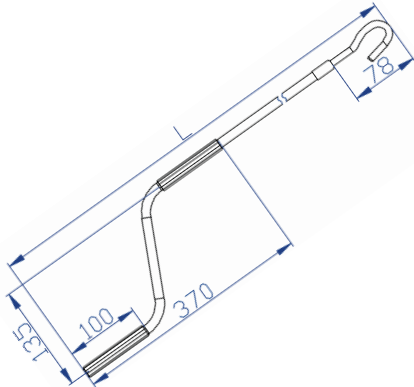
Descripción	Código	Compatibles	Foto
<p>Interruptor Conatel C/ Marco Richi (Chico)</p> <p>Interruptor Conatel C/ Marco Richi P/ Caja Llana (Grande)</p>	<p>ON01</p> <p>ON01</p>	<p>Motores Estándar</p> <p>Motores Metálica</p> <p>Motores Estándar</p> <p>Motores Metálica</p>	
<p>Soporte Omega P / Motor</p>	<p>DOSOP</p>	<p>DO19 DO19E</p> <p>DO80 DO80E</p> <p>DO120 DO140</p> <p>DO220</p>	
<p>Soporte Compacto "Carita"</p>	<p>DOZ264</p>	<p>DO19 DO19E</p> <p>DO80 DO80E</p>	
<p>Soportes Varios</p> <p>Cojinete / Vigna a Cojinete / Vigna</p>	<p>SOPPR</p>	<p>DO19 DO19E</p> <p>DO80 DO80E</p> <p>DO120 DO140</p> <p>DO220</p>	
<p>Manivela P / Motor C / Asist. Manual</p>	<p>80090012</p>	<p>L = 1200</p> <p>L = 1500</p> <p>L = 1800</p> <p>L = 2200</p>	

# Lamas



Descripción	Código	Medidas (mm)	Foto
Lama Hueca ECOCLIM Autoblocante (1)	90030580	A = 39	
Lama Microperforada ECOCLIM Autob. (2)	90032129		
Lama interior ECOCLIM Autoblocante (3)	90030591		
Lama Extrusión ECOCLIM Autoblocante (1)	90030525	A = 47	
Lama Remate ECOCLIM Autob. (2)	90030895		
Lama GV-55 Aluminio Blanco	90030424	A = 55 mm	
Lama GV-55 Aluminio Ciego Blanco	90030432	A = 55 mm	
Lama GV-55 Aluminio Plata	90030425	A = 55 mm	
Lama GV-55 Aluminio Ciego Plata	90030433	A = 55 mm	
Lama GV-55 Aluminio M. Oscuro	90030427	A = 55 mm	
Lama GV-55 Aluminio Ciego M. Oscuro	90030435	A = 55 mm	
Lama GV-55 Aluminio RAL STD*	90030430	A = 55 mm	
Lama GV-55 Aluminio Ciego RAL STD*	90030438	A = 55 mm	
Lama GV-45 Aluminio Blanco	90030370	A = 45 mm	
Lama GV-45 Aluminio Ciego Blanco	90030379	A = 45 mm	
Lama GV-45 Aluminio Plata	90030371	A = 45 mm	
Lama GV-45 Aluminio Ciego Plata	90030380	A = 45 mm	
Lama GV-45 Aluminio M. Oscuro	90030374	A = 45 mm	
Lama GV-45 Aluminio Ciego M. Oscuro	90030383	A = 45 mm	
Lama GV-45 Aluminio RAL STD*	90030377	A = 45 mm	
Lama GV-45 Aluminio Ciego RAL STD* <sub>x</sub>	90030386	A = 45 mm	
Lama Sax PVC DG Blanca Perforada	90032194	A = 47 mm	
Lama Sax PVC DG Blanca Ciega	90032195	A = 47 mm	

\* Información sobre carta de colores

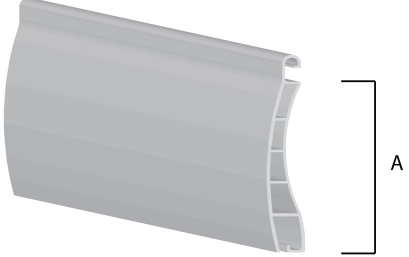
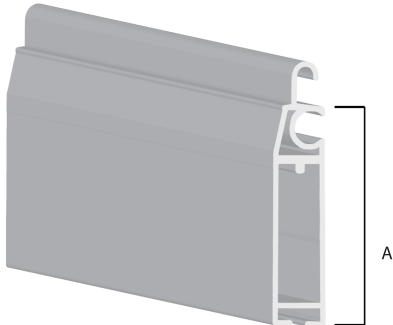
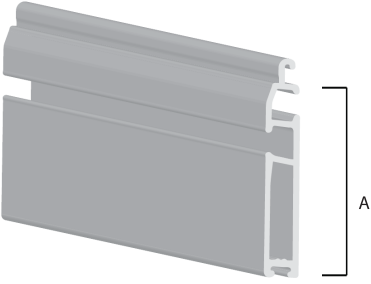
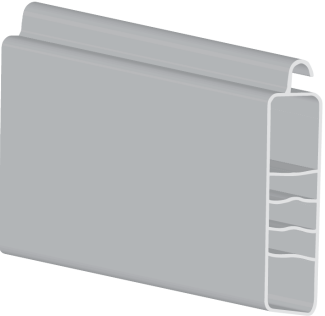
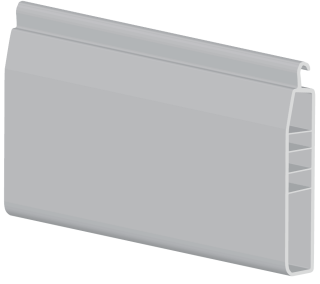
Descripción	Código	Medidas (mm)	Foto
Lama GV-39 PVC Blanco	90030677	A = 39 mm	
Lama GV-39 PVC Ciega Blanco	90030674	A = 39 mm	
Lama GV-39 PVC Gris	90030679	A = 39 mm	
Lama GV-39 PVC Ciega Gris	90030676	A = 39 mm	
Remate / Zócalo Aluminio GV-55 Blanco	90030906	A = 55 mm	
Remate / Zócalo Aluminio GV-55 Plata	90030907	A = 55 mm	
Remate / Zócalo Aluminio GV-55 M. Oscuro	90030911	A = 55 mm	
Remate / Zócalo Aluminio GV-55 RAL STD*	90030915	A = 55 mm	
Remate / Zócalo Aluminio Doble Blanco	90030873	A = 47 mm	
Remate / Zócalo Aluminio Doble Plata	90030874	A = 47 mm	
Remate / Zócalo Aluminio Doble Mad. Osc.	90030878	A = 47 mm	
Remate / Zócalo Aluminio Doble RAL STD*	90030882	A = 47 mm	
Remate / Zócalo Aluminio Doble Natural	90031919	A = 47 mm	
Remate / Zócalo Aluminio Simple Blanco	90030950	A = 47 mm	
Remate / Zócalo Aluminio Simple Plata	90030951	A = 47 mm	
Remate / Zócalo Aluminio Simple RAL STD*	90030958	A = 47 mm	
Remate / Zócalo Lama SAX DG PVC Blanco	90032196		
Remate / Zócalo Lama GV-39 PVC Blanco	90030969		
Remate / Zócalo Lama GV-39 PVC Gris	90030971		

\* Información sobre carta de colores



# Cajones

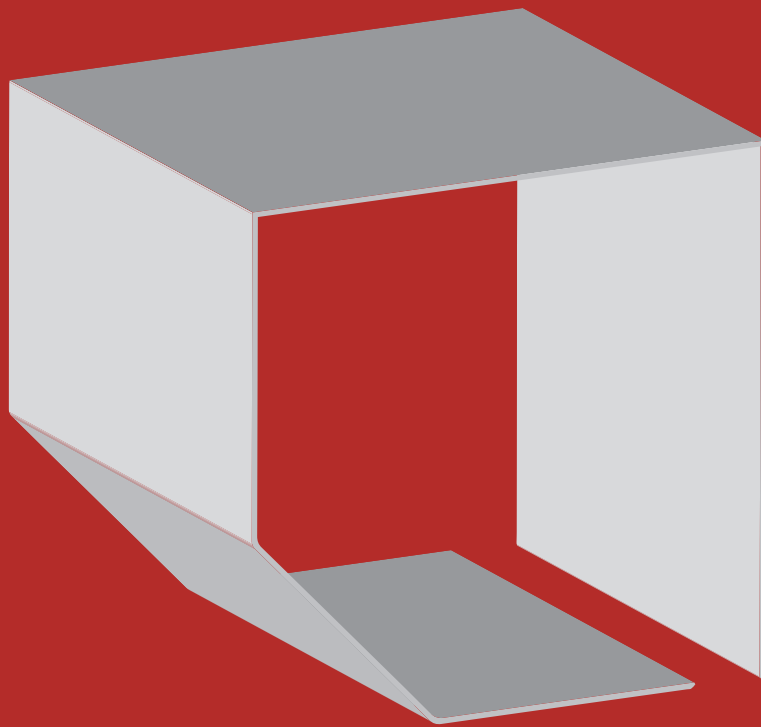

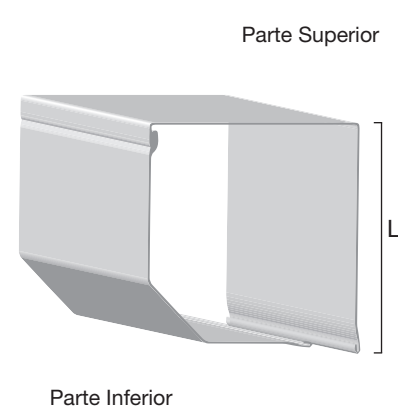
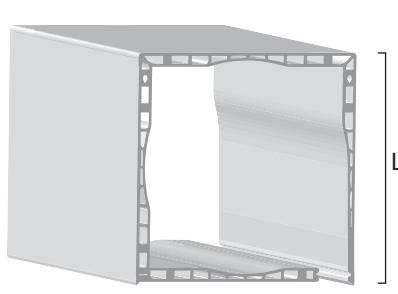
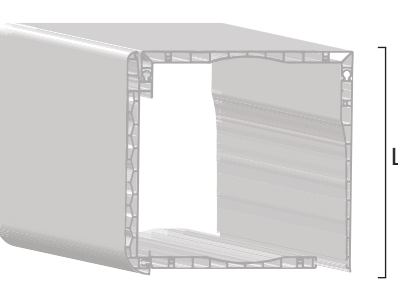
Descripción	Código	Medidas (mm)	Foto
Cajón Alum. 165 - 45° 2P (Superior) Blanco	90031011	L = 165	
Cajón Alum. 165 - 45° 2P (Inferior) Blanco	90031020	L = 165	
Cajón Alum. 165 - 45° 2P (Sup.) Plata	90031012	L = 165	
Cajón Alum. 165 - 45° 2P (Inf.) Plata	90031021	L = 165	
Cajón Alum. 165 - 45° 2P (Sup.) RAL STD*	90031019	L = 165	
Cajón Alum. 165 - 45° 2P (Inf.) RAL STD*	90031028	L = 165	
Cajón Alum. 180 - 45° 2P (Sup.) Blanco	90031029	L = 180	
Cajón Alum. 180 - 45° 2P (Inf.) Blanco	90031038	L = 180	
Cajón Alum. 180 - 45° 2P (Sup.) Gris	90031030	L = 180	
Cajón Alum. 180 - 45° 2P (Inf.) Gris	90031039	L = 180	
Cajón Alum. 180 - 45° 2P (Sup.) RAL STD*	90031037	L = 180	
Cajón Alum. 180 - 45° 2P (Inf.) RAL STD*	90031046	L = 180	
Cajón Alum. 165 - 90° 4 Partes Blanco	90032145	L = 165	
Cajón Alum. 180 - 90° 4 Partes Blanco	90032151	L = 180	
Cajón PVC Enrasado 155 Blanco	90031155	L = 155	
Cajón PVC Enrasado 155 Gris	90031157	L = 155	
Cajón PVC Enrasado 185 Blanco	90031165	L = 185	
Cajón PVC Enrasado 185 Gris	90031167	L = 185	
Cajón PVC Enrasado 200 Blanco	90032167	L = 200	
Cajón PVC DECO Enrasado 155 Blanco	90032169	L = 155	
Cajón PVC DECO Enrasado 200 Blanco	90032171	L = 200	
Cajón PVC DECO Enrasado 200 Nogal (4)*	90032172	L = 200	

\* Información sobre carta de colores

# Testeros

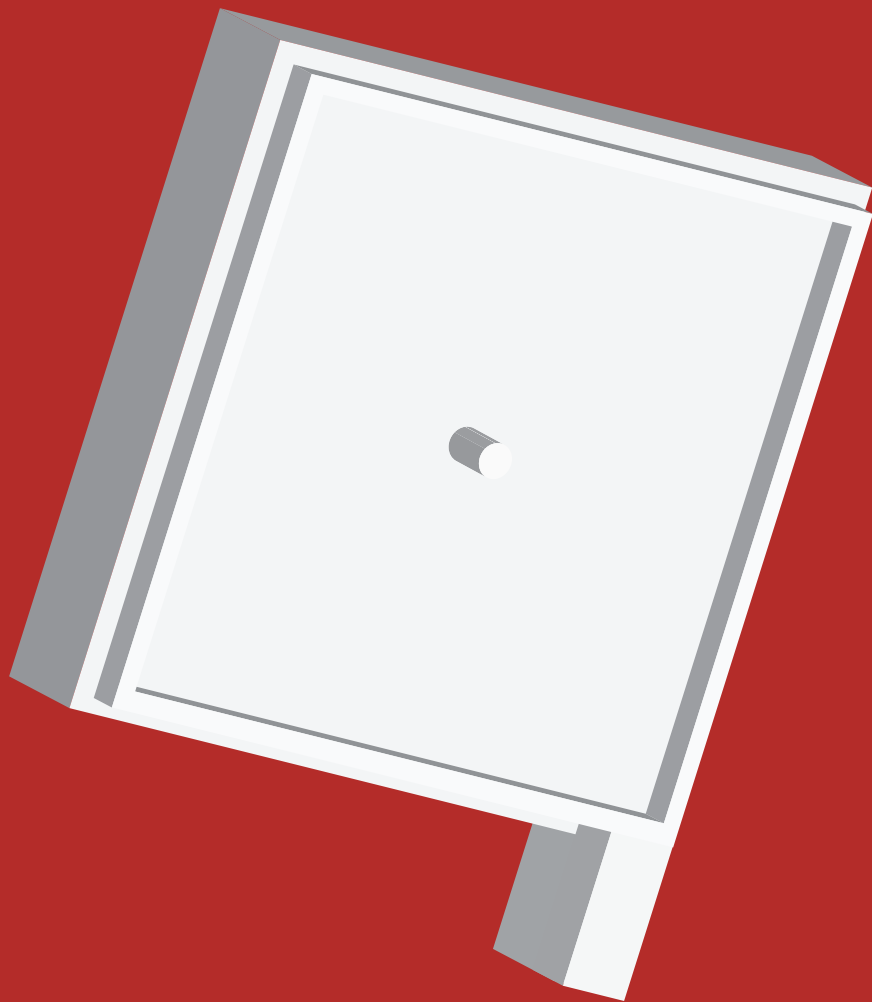

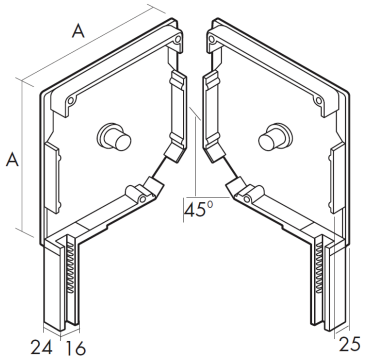
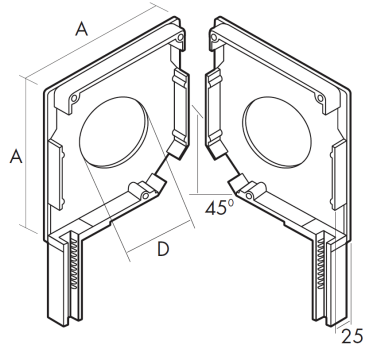
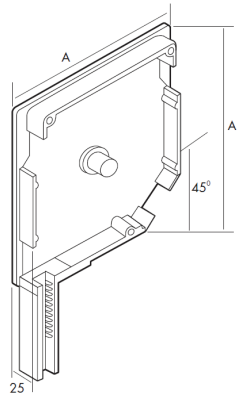
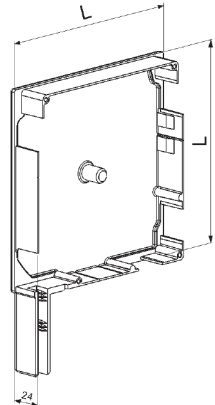
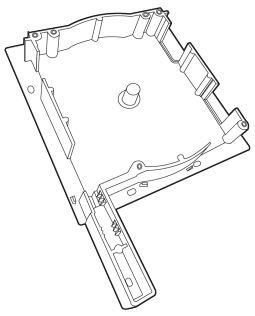
Descripción	Código	Medidas (mm)	Foto
<p>Jueg. Testero Central Alum. 165 - 45°</p> <p>Jueg. Testero Central Alum. 180 - 45°</p>	<p>70080125</p> <p>70080126</p>	<p>A = 165</p> <p>A = 180</p>	
<p>Jueg. Testero Central Alum. 165 - 45° - T72</p> <p>Jueg. Testero Central Alum. 180 - 45° - T72</p>	<p>70080138</p> <p>70080139</p>	<p>A = 165 D = 72</p> <p>A = 180 D = 72</p>	
<p>J. Test. Alum. 165 - 45 T. Di Moro Export</p> <p>J. Test. Alum. 180 - 45 T. Di Moro Export</p> <p>J. Test. Alum. 165 - 45 Plata Export</p> <p>J. Test. Alum. 180 - 45 Plata Export</p> <p>J. Test. Alum. 165 - 45 Blanco Export</p> <p>J. Test. Alum. 180 - 45 Blanco Export</p> <p>J. Test. Alum. 165 - 45 Marrón Export</p> <p>J. Test. Alum. 180 - 45 Marrón Export</p>	<p>70080193</p> <p>70080196</p> <p>70080236</p> <p>70080238</p> <p>70080509</p> <p>70080513</p> <p>70080901</p> <p>70080902</p>	<p>A = 165</p> <p>A = 180</p> <p>A = 165</p> <p>A = 180</p> <p>A = 165</p> <p>A = 180</p> <p>A = 165</p> <p>A = 180</p>	
<p>J. Testeros Alum. 165 - 90 Blanco Export</p> <p>J. Testeros Alum. 180 - 90 Blanco Export</p>	<p>70080484</p> <p>70080488</p>	<p>L = 165</p> <p>L = 180</p>	
<p>J. Testeros PVC 155 Enrasado Blanco</p> <p>J. Testeros PVC 155 Enrasado Gris</p> <p>J. Testeros PVC 185 Enrasado Blanco</p> <p>J. Testeros PVC 185 Enrasado Gris</p> <p>J. Testeros PVC 200 Enrasado Blanco</p> <p>J. Testeros Alum. 200 Enrasado Blanco</p>	<p>70081902</p> <p>70081904</p> <p>70081903</p> <p>70081905</p> <p>70081952</p> <p>70080529</p>		

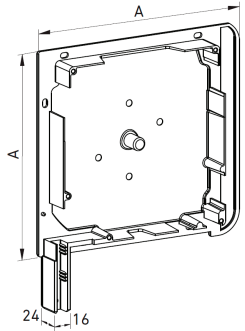
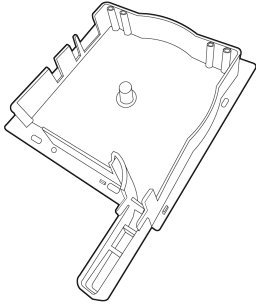
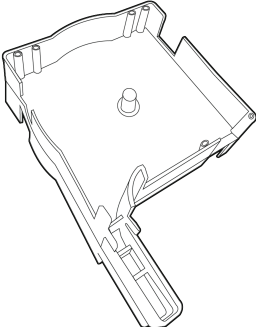
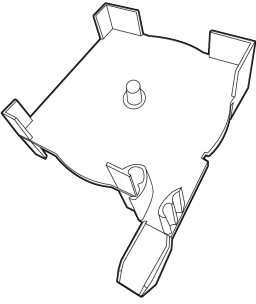
Descripción	Código	Medidas (mm)	Foto
<p>J. Test. PVC 155 DECO Emb. Inc. Blanco</p> <p>J. Test. PVC 200 DECO Emb. Inc. Blanco</p> <p>J. Test. PVC 200 DECO Emb. Inc. Nogal</p>	<p>70081954</p> <p>70081956</p> <p>70081957</p>	<p>A = 155</p> <p>A = 200</p> <p>A = 200</p>	
<p>J. Test. PVC 155 Moc. Emb. Inc Blanco</p> <p>J. Test. PVC 155 Moc. Emb. Inc Gris</p> <p>J. Test. PVC 185 Moc. Emb. Inc Blanco</p> <p>J. Test. PVC 185 Moc. Emb. Inc Gris</p>	<p>70081928</p> <p>70081929</p> <p>70081931</p> <p>70081932</p>	<p>L = 155</p> <p>L = 185</p> <p>L = 155</p> <p>L = 185</p>	
<p>Testero Cent. PVC 155 P/ DG Alum.</p> <p>Testero Cent. PVC 185 P/ DG Alum.</p>	<p>70081934</p> <p>70081936</p>	<p>L = 170</p>	
<p>Testero Cent. PVC 155 P / DG PVC</p> <p>Testero Cent. PVC 185 P / DG PVC</p>	<p>70081938</p> <p>70081939</p>	<p>A = 250</p> <p>A = 290</p> <p>A = 290</p>	

# Guías



Descripción	Código	Medidas (mm)	Foto
Guía Alum. Ext. H25 Blanco Guía Alum. Ext. H25 Plata Guía Alum. Ext. H25 RAL STD* Guía Alum. Ext. H25 Natural	90030805 90030806 90030813 90031306	A = 53 P = 21,60 A = 53 P = 21,60 A = 53 P = 21,60 A = 53 P = 21,60	
Guía Alum. Monoblock HSL Blanco Guía Alum. Monoblock HSL Plata Guía Alum. Monoblock HSL RAL STD* Guía Alum. Monoblock HSL Natural	90031223 90031224 90031231 90031309	A = 53 P = 21,60 T = 120 o 150 A = 53 P = 21,60 T = 120 o 150 A = 53 P = 21,60 T = 120 o 150 A = 53 P = 21,60 T = 120 o 150	
Guía "U" Tradicional Alum.	AB01	A = 22 P = 22	
Guía PVC Ext. HL Blanco Guía PVC Ext. HL Gris	90030847 90030849	A = 53 P = 22 A = 53 P = 22	
Guía Alum. Ext. Doble 2T Blanco Guía Alum. Ext. Doble 2T Plata Guía Alum. Ext. Doble 2T RAL STD* Guía Alum. Ext. Doble 2T Natural	90030827 90030828 90030835 90030835	A = 108,50 P = 21,60 A = 108,50 P = 21,60 A = 108,50 P = 21,60 A = 108,50 P = 21,60	

\* Información sobre carta de colores

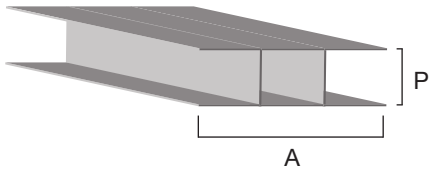
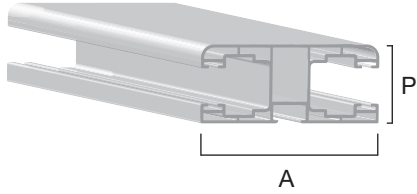
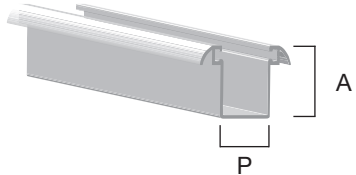

Descripción	Código	Medidas (mm)	Foto
Guía Alum. Tradicional Doble	AB02	A = 66 P = 22	
Guía PVC Ext. Doble	90031315	A = 70 P = 30	
Guía Alum. Insertar P/ 55mm Blanco Guía Alum. Insertar P/ 55mm Plata Guía Alum. Insertar P/ 55mm RAL STD* Guía Alum. Insertar P/ 45mm Blanco Guía Alum. Insertar P/ 45mm Plata Guía Alum. Insertar P/ 45mm RAL STD* Guía Alum. Insertar P/ 45mm Natural	90032157 90032158 90032158 90031245 90031246 90031253 90031311	A = 26 P = 19 A = 26 P = 19 A = 26 P = 19 A = 26 P = 19 A = 24,50 P = 16 A = 24,50 P = 16 A = 24,50 P = 16	

# Ejes

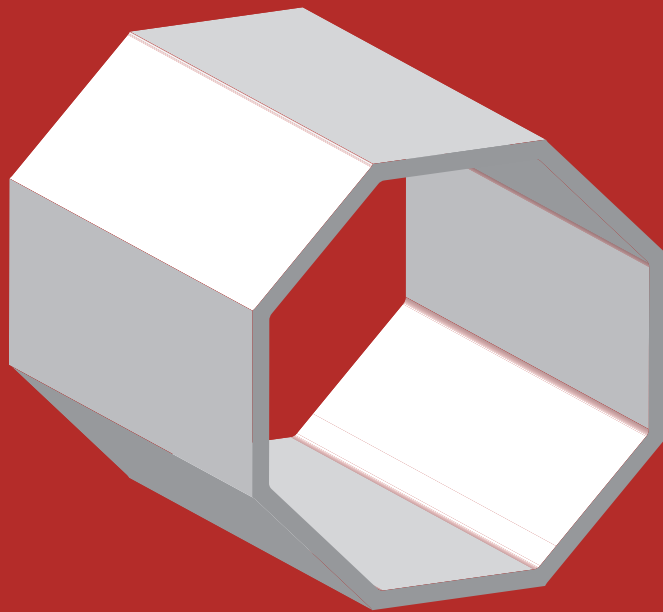

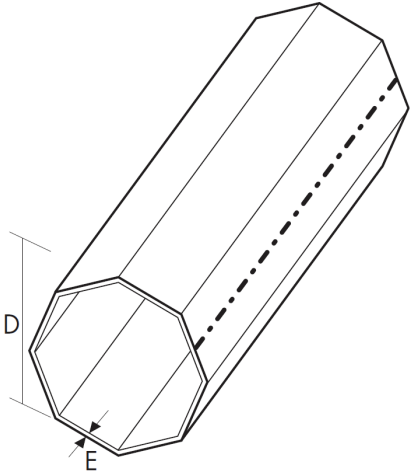
Descripción	Código	Medidas (mm)	Foto
Eje 40 mm Octogonal Galvanizado	70020026	D = 40 mm A = 0,4	
Eje 60 mm Octogonal Galvanizado	70010043	D = 60 mm A = 0,6	
Eje 70 mm Octogonal Galvanizado	70010046	D = 70 mm A = 1,2	

# Recogedores

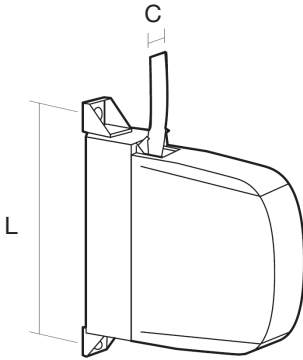
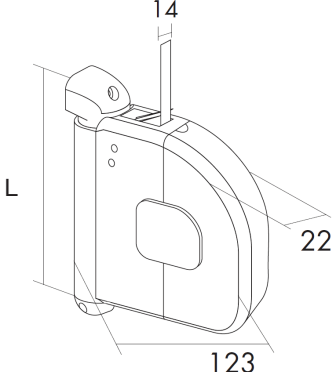
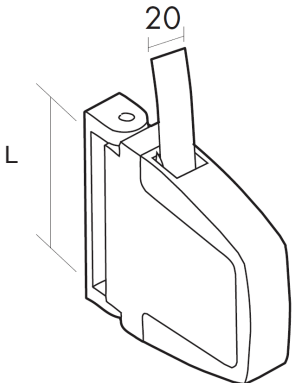
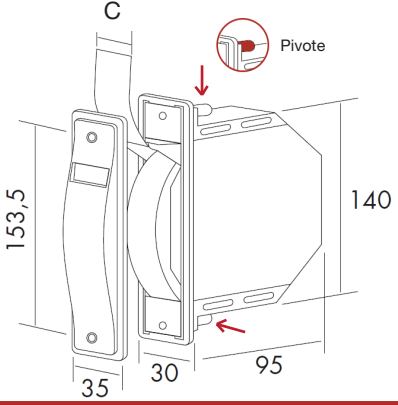
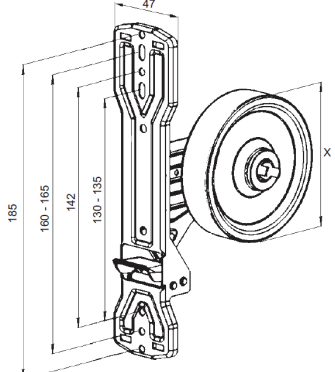

Descripción	Código	Medidas (mm)	Foto
Rec. Mini Blanco / Cinta 14 Pintas	70040193	L = 151 C = 14	
Rec. Mini Blanco / Cinta 18 Pintas	70040143	L = 151 C = 18	
Rec. Mini Marrón / Cinta 14 Marrón	70040006	L = 151 C = 14	
Rec. Mini Marrón / Cinta 18 Marrón	70040114	L = 151 C = 18	
Rec. Mini Gris / Cinta 14 Pintas	70040667	L = 151 C = 14	
Rec. Mini Gris / Cinta 18 Pintas	70040570	L = 151 C = 18	
Rec. Mini Export Marrón / Cinta 14 Marrón	70040302	L = 151	
Rec. Mini Export Blanco / Cinta 14 Pintas	70040317	L = 151	
Rec. Eurosax Blanco / Cinta 20 Pintas	70040021	L = 100	
Rec. Universal S/Piv. Blanco / C 14 Pintas	70040248	C = 14	
Rec. Universal S/Piv. Gris / C 14 Pintas	70040249	C = 14	
Rec. Universal S/Piv. Marrón / C 14 Marrón	70040250	C = 14	
Rec. Universal C/Piv. Blanco / C 18 Pintas	70040251	C = 18	
Rec. Universal C/Piv. Marrón / C 18 Marrón	70040253	C = 18	
Rec. Universal S/Piv. Blanco / C 18 Pintas	70040254	C = 18	
Rec. Universal C/Piv. Gris / C 18 Gris	70040703	C = 18	
Rec. Universal S/Piv. Gris / C 18 Pintas	70040255	C = 18	
Rec. Universal S/Piv. Marrón / C 18 Marrón	70040256	C = 18	
Rec. KLIKO P / Cinta 6 mts	70040616	X = 85	
Rec. KLIKO P / Cinta 8 mts	70040618	X = 85	

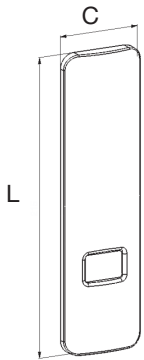
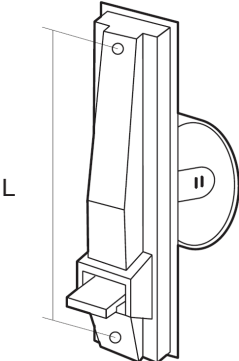
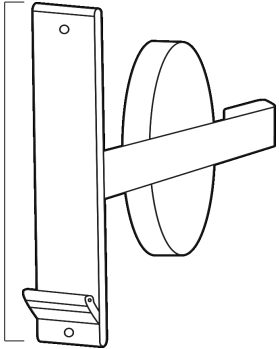
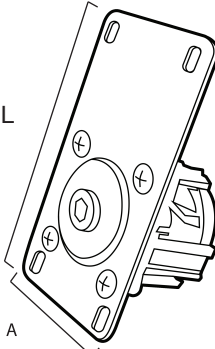
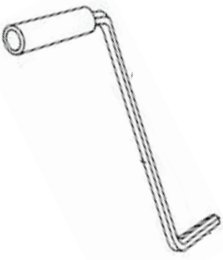
Descripción	Código	Medidas (mm)	Foto
Placa KLIKO PL. S / Taladros Blanco	70040638	L = 215 C = 60	
Rec. Plástico Grande Blanco	70040058	L = 170	
Rec. Metálico Vicgervo 10 mts Fte. Corto Rec. Metálico Vicgervo 10 mts Fte. Largo Rec. Metálico Vicgervo 12 mts C / Pata	RI10 RI10 RI12	A = 250 A = 290 A = 290	
Cuerpo / Máquina Maravilla T2 Cuerpo / Máquina Maravilla T1	BA06 BA03	L = 14 A = 7,5 L = 11 A = 6	
Manivela Maravilla T2 Manivela Maravilla T1	BA07 BA04		

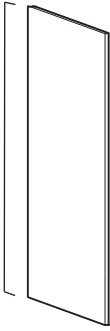
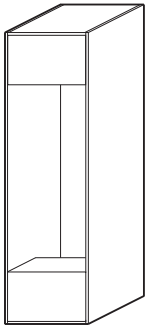
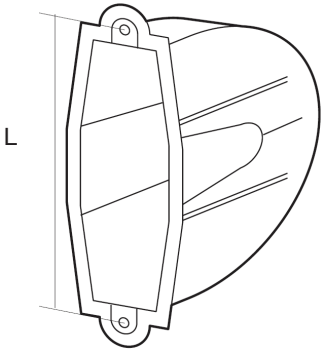
Descripción	Código	Medidas (mm)	Foto
Madera P/ Tapar Hueco Enrollador C/ Motorización.	TAPM	L = 220  L = 290	
Caja de Madera P/ Rec. Trad. 4 mts Caja de Madera P/ Rec. Trad. 6 mts Caja de Madera P/ Rec. Trad. 8 mts Caja de Madera P/ Rec. Trad. 10 mts	CA01 CA01 CA01 CA02		
Cajetín Plástico	70040094	L = 170	



# Discos

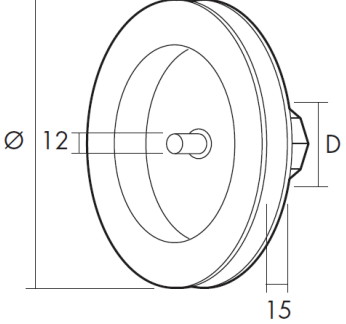
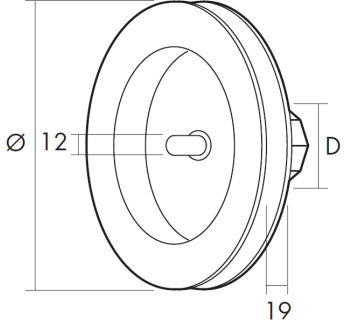
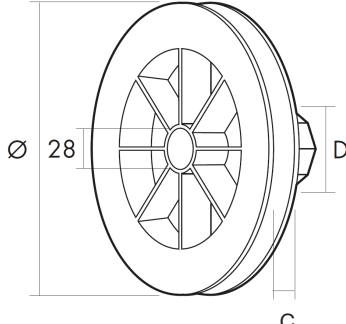
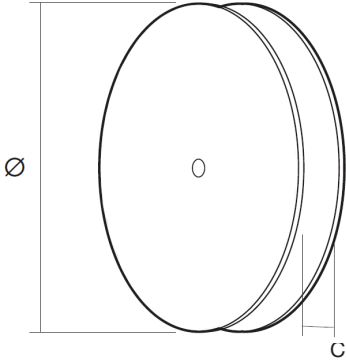
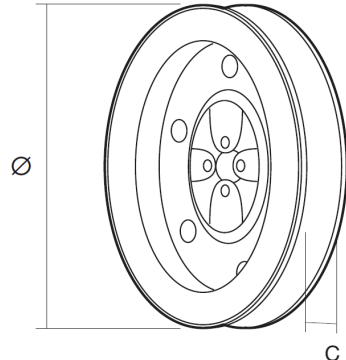

Descripción	Código	Medidas (mm)	Foto
Disco PL. 120X40 OCT E12 C14	70020014	Ø = 120 D = 40	
Disco PL. 140X40 OCT E12 C18	70020020	Ø = 140 D = 40	
Disco PL. 120X40 OCT P/ROD. 28 C18	70020032	Ø = 120 D = 40 C = 19	
Disco PL. 140X40 OCT P/ROD. 28 C18	70020034	Ø = 140 D = 40 C = 19	
Disco PL. 140X40 OCT P/ROD. 28 C14	70020179	Ø = 140 D = 40 C = 15	
Disco PL. 123X40 OCT P/ROD. 28 C14	70020180	Ø = 123 D = 40 C = 15	
Disco Madera Tradicional 20	CA25	Ø = 200 C = 22	
Disco Madera Tradicional 23	CA25	Ø = 230 C = 22	
Disco Madera Tradicional 25	CA25	Ø = 250 C = 22	
Disco Madera Tradicional 27	CA27	Ø = 270 C = 22	
Disco Madera P/ Linga 23	CA26	Ø = 230 C = 11	
Disco Galvanizado Tradicional 23	BA23	Ø = 230 C = 22	
Disco Galvanizado P/ Linga 23	BA23L	Ø = 230 C = 11	

# Capsulas

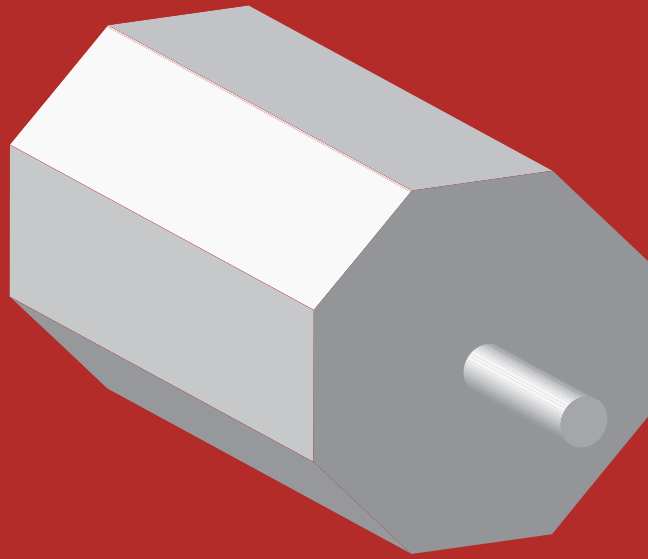

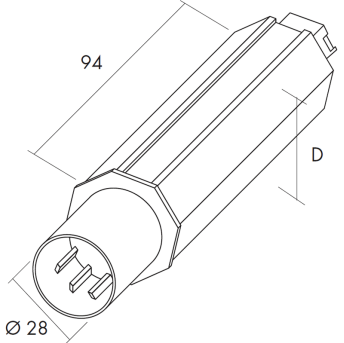
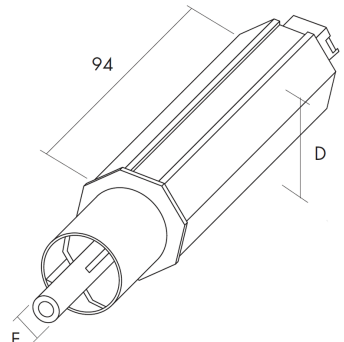
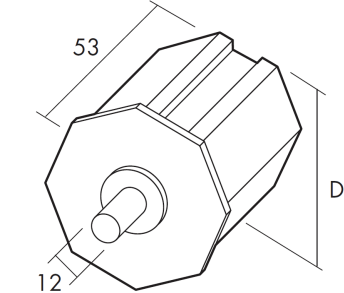
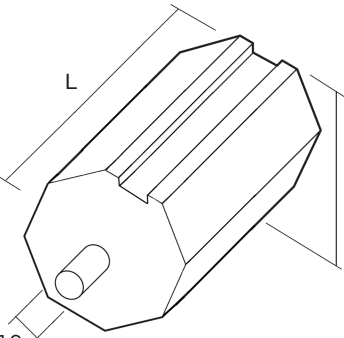
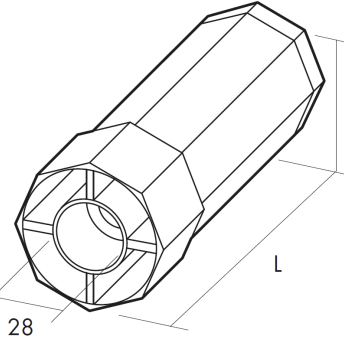
Descripción	Código	Medidas (mm)	Foto
Cápsula PL. OCT. Telescópica P/ROD. 28	70030012	D = 40	
Cápsula PL. OCT. Telescópica E12	70030016	E = 12 D = 40	
Cápsula PL. 60 OCT. E12 Cápsula PL. 70 OCT. E12	70030023 70030024	D = 60 D = 70	
Cápsula Madera OCT. 40 Cápsula Madera OCT. 60 Cápsula Madera OCT. 70	CA70 CA70 CA70	D = 40 L = 90 D = 60 L = 120 D = 70 L = 120	
Cápsula PL. OCT. 60 Larga P/ROD. 28	70030053	D = 60 L = 150	

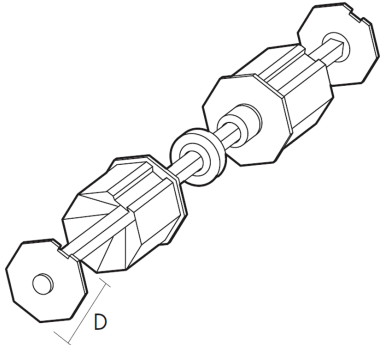
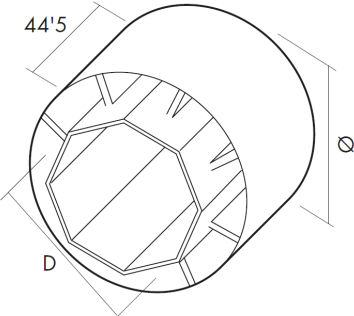
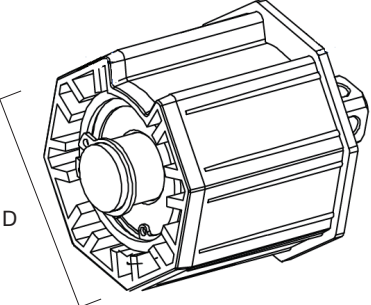
Descripción	Código	Medidas (mm)	Foto
<p>Cápsula PL. 60 OCT. Doble Regulable</p> <p>Cápsula PL. 70 OCT. Doble Regulable</p>	<p>70030030</p> <p>70030031</p>	<p>D = 60</p> <p>D = 60</p>	
<p>Anillo PL. Compensación 70 OCT. D130</p>	<p>70030034</p>	<p>Ø = 130 D = 70</p>	
<p>Cápsula Reforzada 70 OCT. (Metálica)</p>	<p>CPRU70</p>	<p>D = 70</p>	

# Pasacintas

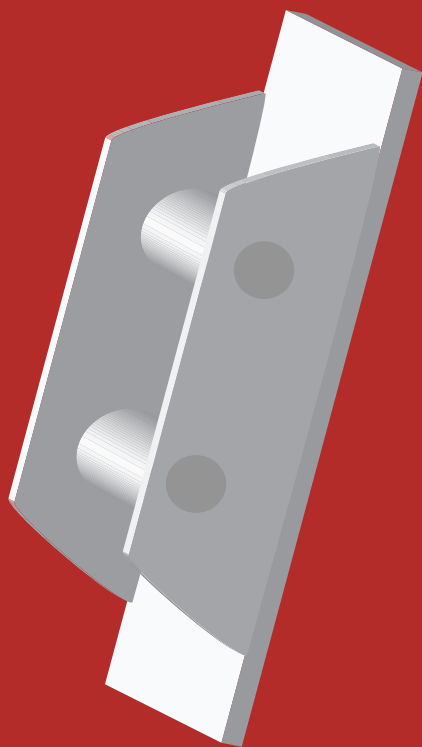

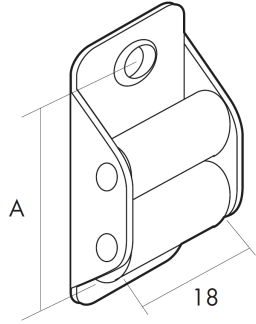
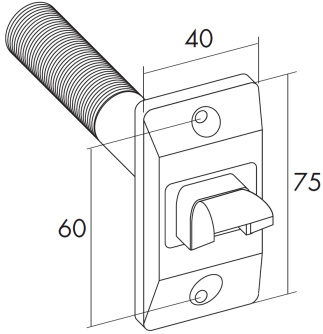
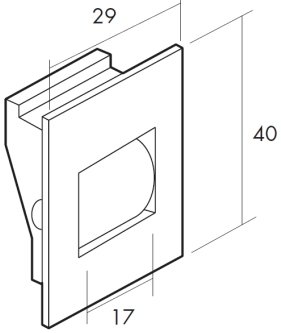
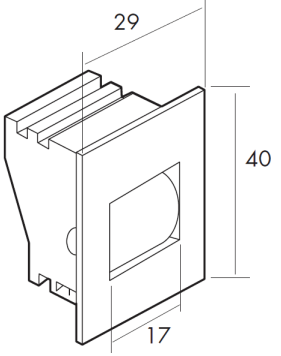
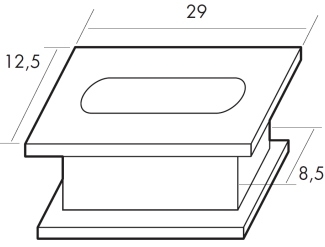
Descripción	Código	Medidas (mm)	Foto
Pasacinta Metálico Mini Normal R / Nylon	70050001	A = 36	
Pasacinta Boca de Dragón C14 Blanco Pasacinta Boca de Dragón C14 Marrón Pasacinta Boca de Dragón C14 Gris Pasacinta Boca de Dragón C18 Blanco Pasacinta Boca de Dragón C18 Marrón Pasacinta Boca de Dragón C18 Gris	70050003 70050004 70050005 70050179 70050184 70050182		
Pasacinta Compacto P / Alum. Blanco Pasacinta Compacto P / Alum. Marrón Pasacinta Compacto P / Alum. Gris	70050024 70050025 70050026		
Pasacinta Compacto PVC Blanco C18 Pasacinta Compacto PVC Marrón C18 Pasacinta Compacto PVC Gris C18	70050032 70050033 70050034		
Pasacinta Salida Inferior Blanco C20 Pasacinta Salida Inferior Gris C20	70120040 70120041		



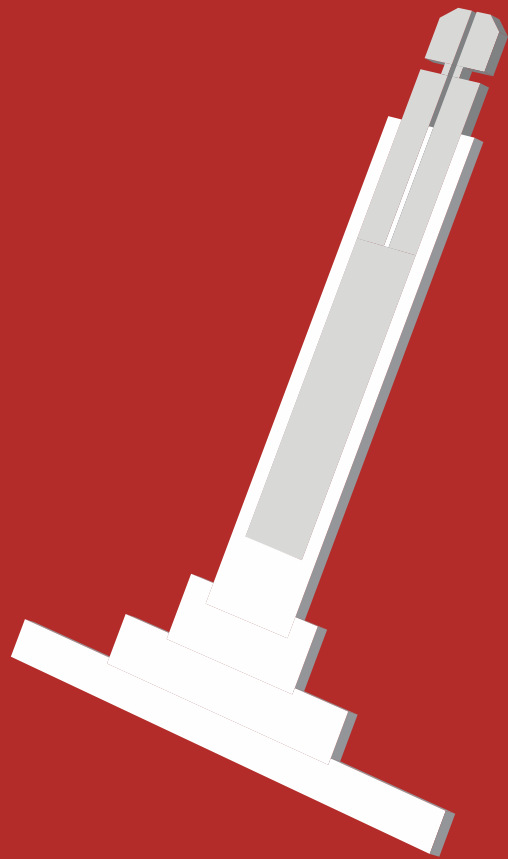

# Accesorios

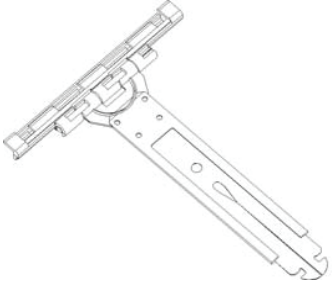
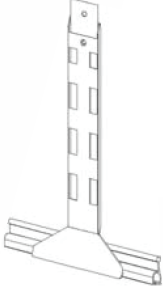
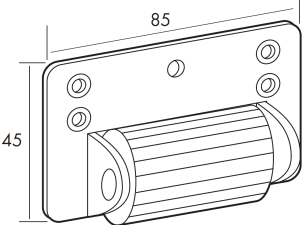
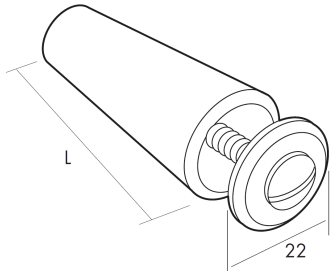
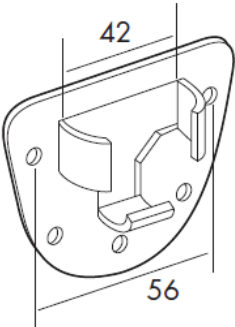

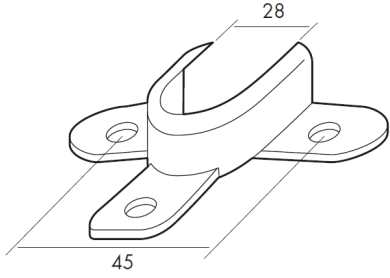
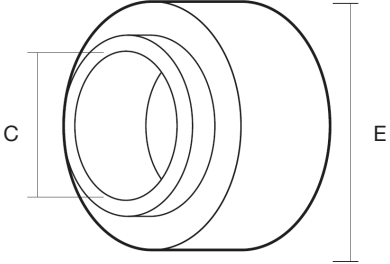
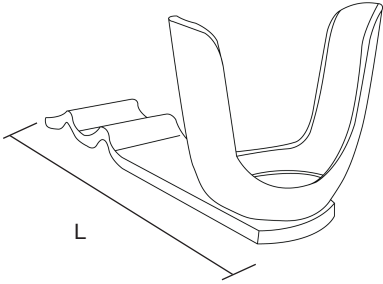
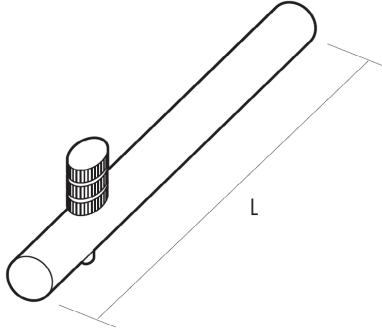
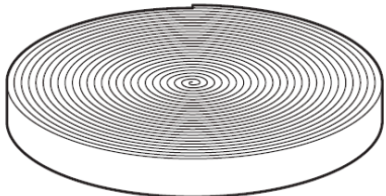
Descripción	Código	Medidas (mm)	Foto
Tirante Mixto Lama 39 Perfil Reforzado	70070100		
Tirante Fleje Taladros Lama Recta 240 (P/ Lama GV-55 Alum.)  Tirante Fleje Autoanclaje R1000 130 C/ Funda (P/ Lama ECOCLIM)	70070157  70070155		
Rodillo de Empuje ( Separador )	70050054		
Tope con Arandela 40 Blanco Tope con Arandela 40 Gris Tope con Arandela 40 Marrón Oscuro Tope con Arandela 60 Blanco Tope con Arandela 60 Gris Tope con Arandela 60 Marrón Oscuro	70050449 70050453 70050459 70050087 70050089 70050092	L = 40 L = 40 L = 40 L = 60 L = 60 L = 60	
Soporte Obra P / Rodamiento 42 mm	70060013		

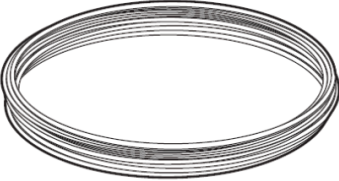
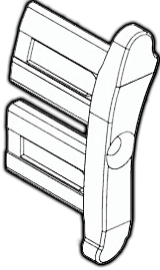
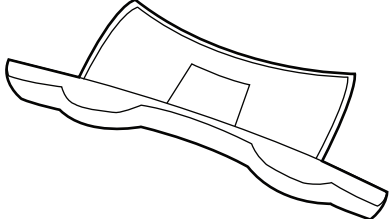
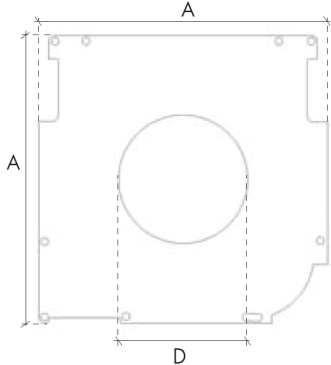
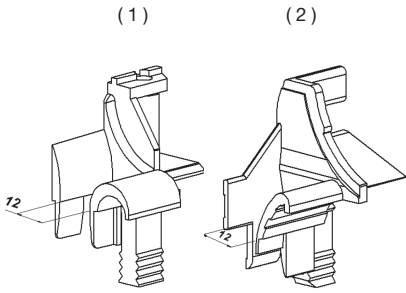
Descripción	Código	Medidas (mm)	Foto
Soporte P / Rodamiento 28 mm	70060017		
Rodamiento / Rulemán 28 Pista Nylon Rodamiento / Rulemán 42 Pista Nylon	70060021 70060024	C = 12 E = 28 C = 12 E = 42	
Soporte Pared Con Rodamiento	70060129	L = 115	
Cerrojo / Pasador de Seguridad Para Zócalo con Ranura	70120017	L = 80	
Cinta de Algodón Tradicional Cinta P / Sin Albañilería 14 mm Cinta P / Sin Albañilería 18 mm	BO01 70070026 70070028	Ancho = 22 Ancho = 14 Ancho = 18	

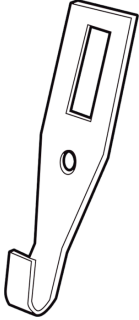
Descripción	Código	Medidas (mm)	Foto
Cable de Acero Alma de Tela	PE01	Espesor = 2	
J. Tapón GV-45 Autobloc. Ecoclim J. Tapón GV-45 Hueca Ecoclim J. Tapón GV-45 Superior Ecoclim J. Tapón GV-45 Inferior Ecoclim	90031212 90031213 90031214 90031215		
J. Tapón GV-45 / ECO J. Tapón GV-55	90031204 90031207		
J. Placas Contención 165-90 T/64 J. Placas Contención 137-90 T/55 J. Placas Contención 165-90 T/55 J. Placas Cont. 155 T/55 P/Test. Emb. Inc. J. Placas Cont. 155 T/72 P/Test. Emb. Inc. J. Placas Cont. 185 T/55 P/Test. Emb. Inc. J. Placas Cont. 185 T/72 P/Test. Emb. Inc.	70081092 70080141 70080147 70081940 70081941 70081942 70081943	A = 165 D = 64 A = 137 D = 55 A = 165 D = 55 A = 155 D = 55 A = 155 D = 72 A = 185 D = 55 A = 185 D = 72	
Juego de Embudos C/ Rodillo Blanco ( 1 ) Juego de Embudos Enrasados Blanco ( 2 )	70050098 70050161		

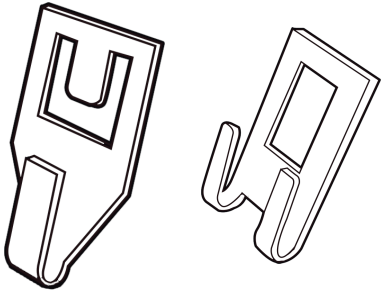
Descripción	Código	Medidas (mm)	Foto
Gancho Simple P/ Cortina Madera	VI01		
Gancho Terminal P/ Cort. Madera	VI02		
Juego de Ganchos Dobles P/ Cort. Madera	VI03		

# Carta de Colores



Muestra	Código	Nombre	Compatibles
	5	Blanco (RAL 9016)	Lamas, Cajones, Guías y Testeros
	6	Gris / Plata (RAL 9006) (Pintado o anodizado)	Lamas, Cajones, Guías y Testeros
	9	Marrón (RAL 8014) (Chocolate)	Lamas, Cajones, Guías y Testeros
	10	Test Di Moro (RAL 8019) (Anolock)	Lamas, Cajones, Guías y Testeros
	12	Verde Ingles (RAL 6005)	Lamas, Cajones, Guías y Testeros
	13	Negro (RAL 9005)	Lamas, Cajones, Guías y Testeros
	4	Nogal Oscuro (Nº 2)	Lamas
	11	Madera Oscuro	Lamas

Los colores en pantalla suelen variar de la realidad - Se recomienda solicitar muestras reales en la empresa.



# **P**ROPERFIL

Tels.: 2613 5007 - 2619 7470  
J.J. Dessalines 2020  
Montevideo